

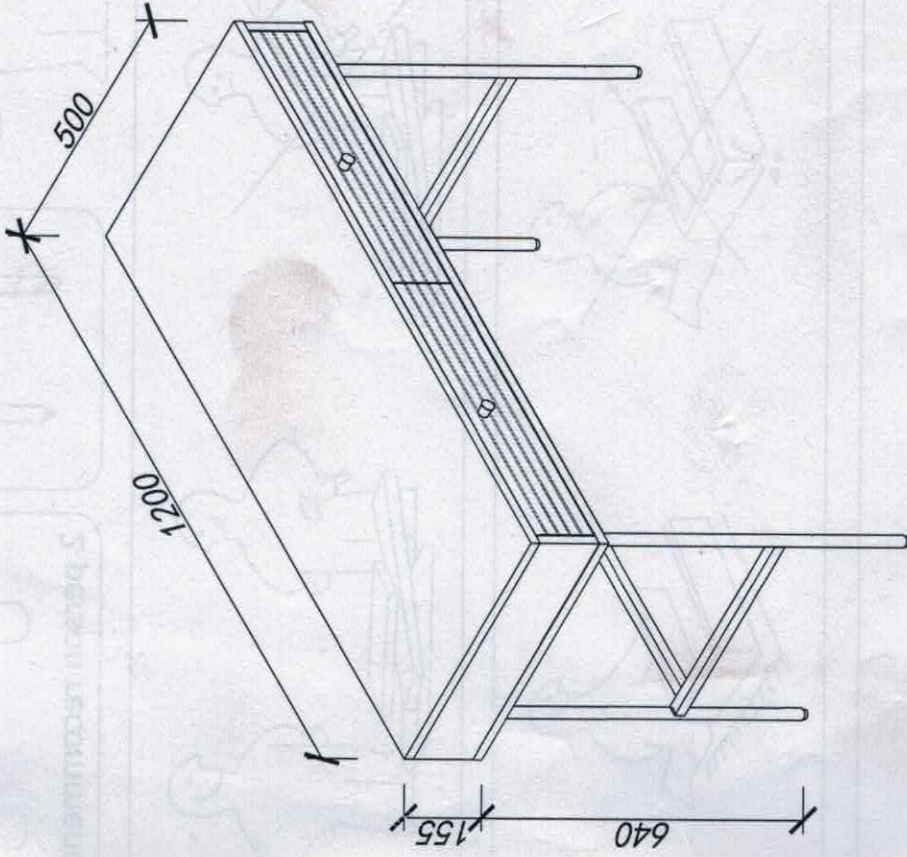

4UDESIGNED.NL
betaalbare designmeubelen

Assembly Instruction
LINEWD01 Work desk



Panel No	Panel Sizes	Quantity
7	580*115*18	1
8	525*80*12	2
9	400*80*12	2
10	400*80*12	2
11	525*398*6	2

Panel No	Panel Sizes	Quantity
1	1200*500*16	1
2	1200*500*16	1
3	1198*498*16	2
4	1198*460*16	1
5	1298*1170*6	1
6	580*115*18	1

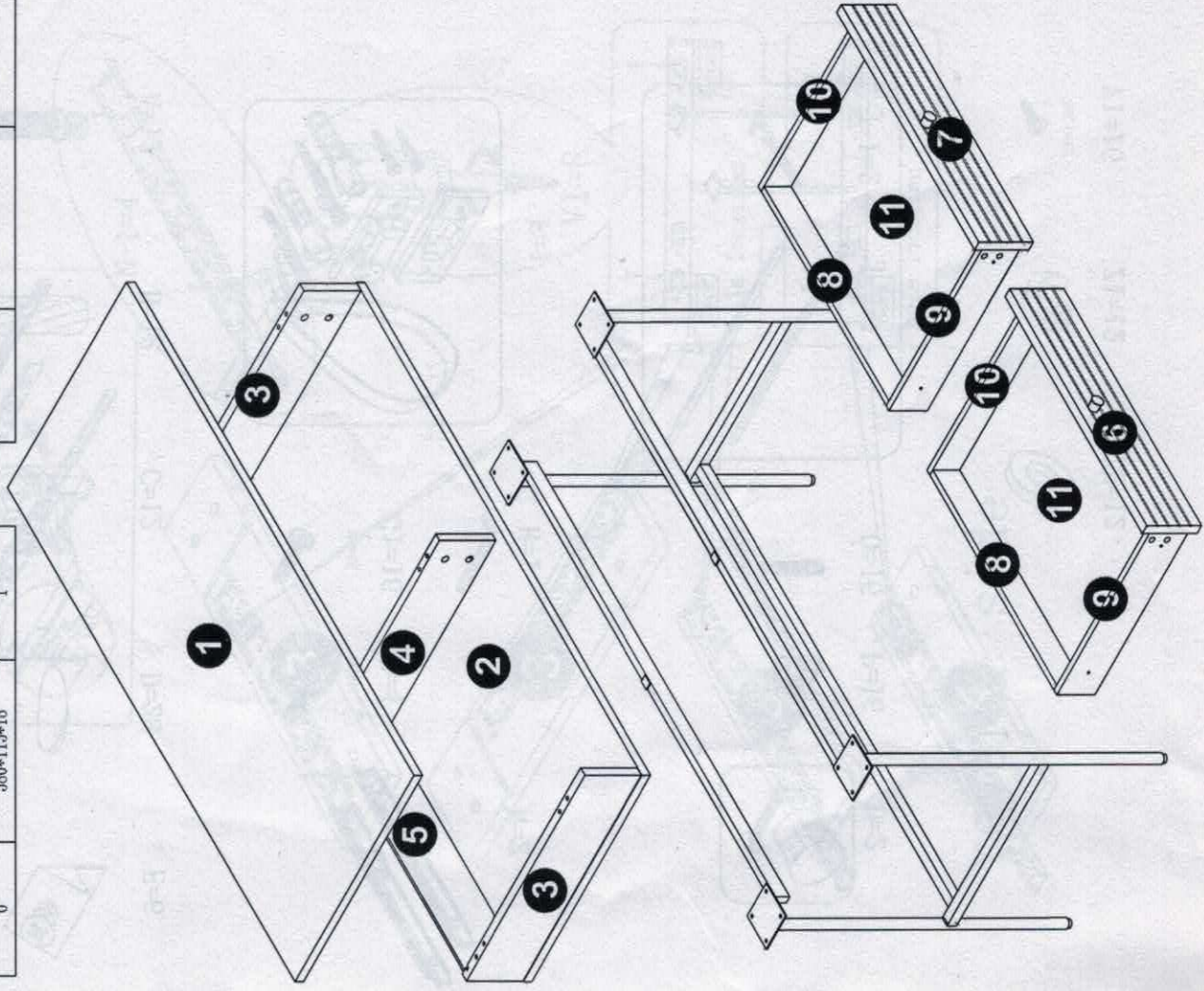
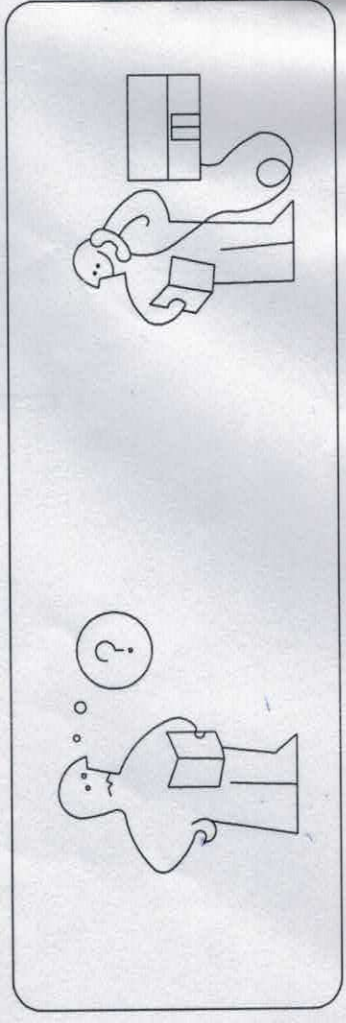
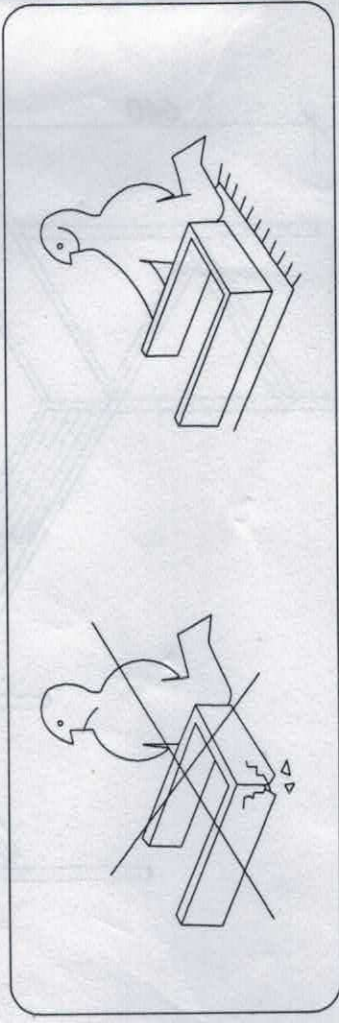
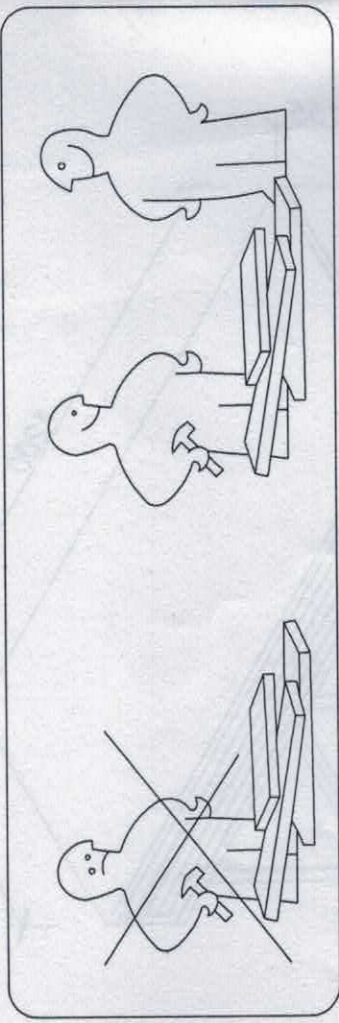
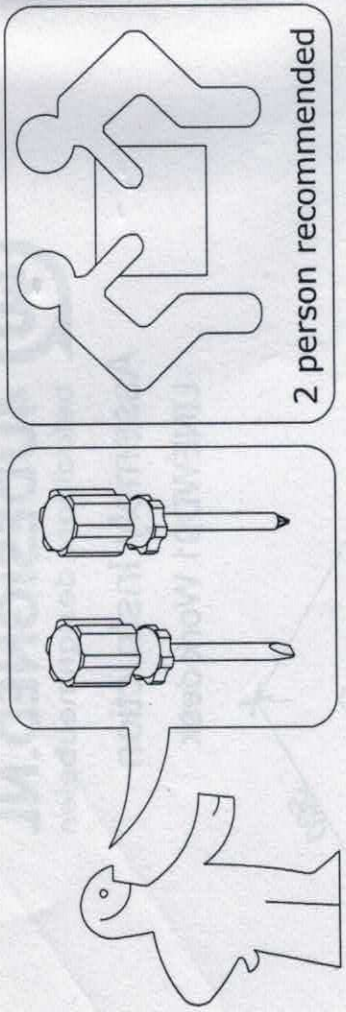

Fittings



A=12



B=12



C=12



D=28



E=6

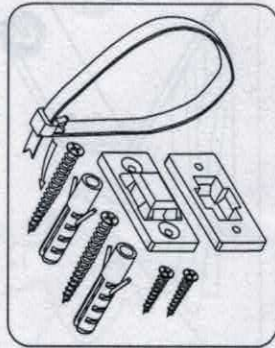

F=1



G1=16



G2=4

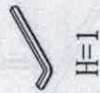

H=1

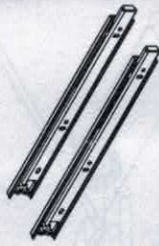

N=2



O=16



P=16



U=2

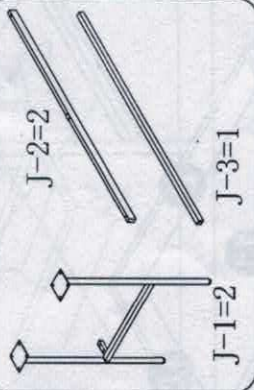

J-1=2

J-2=2

J-3=1



V1=16



Z1=12



Z2=12

1

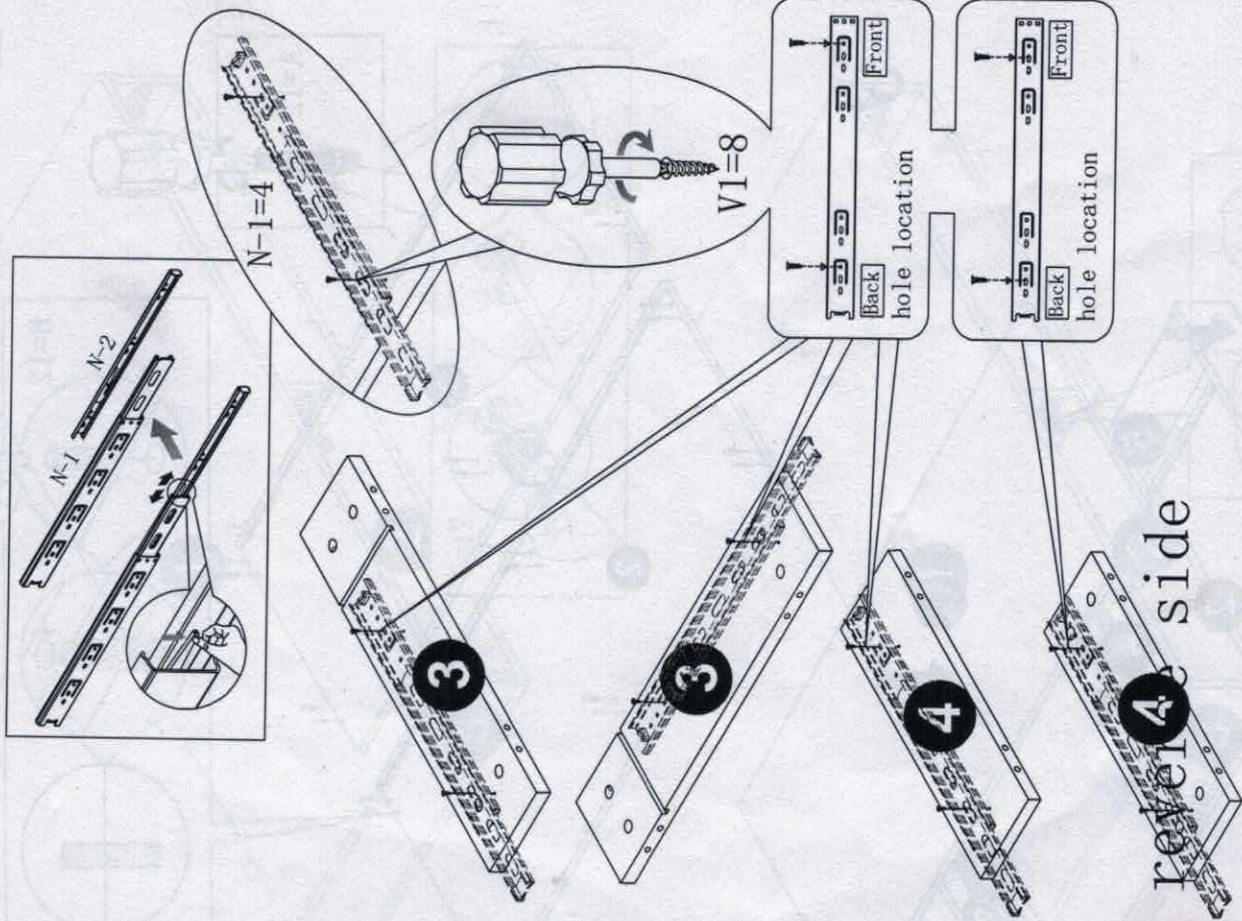

2

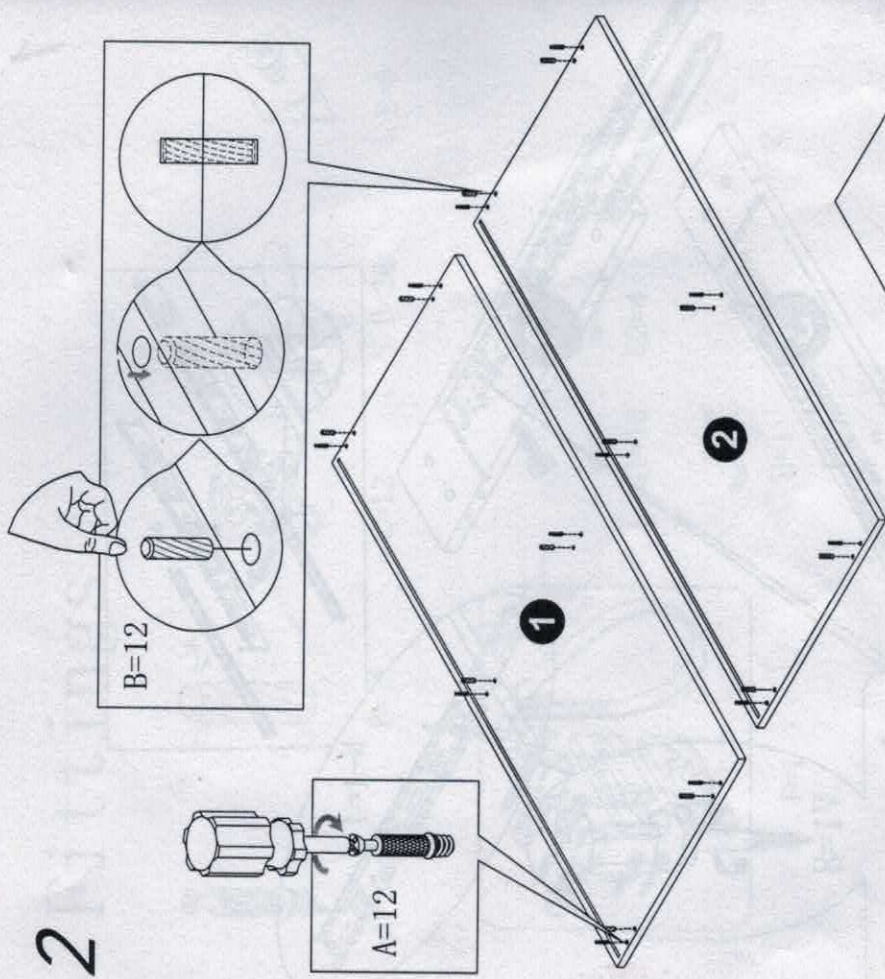

4

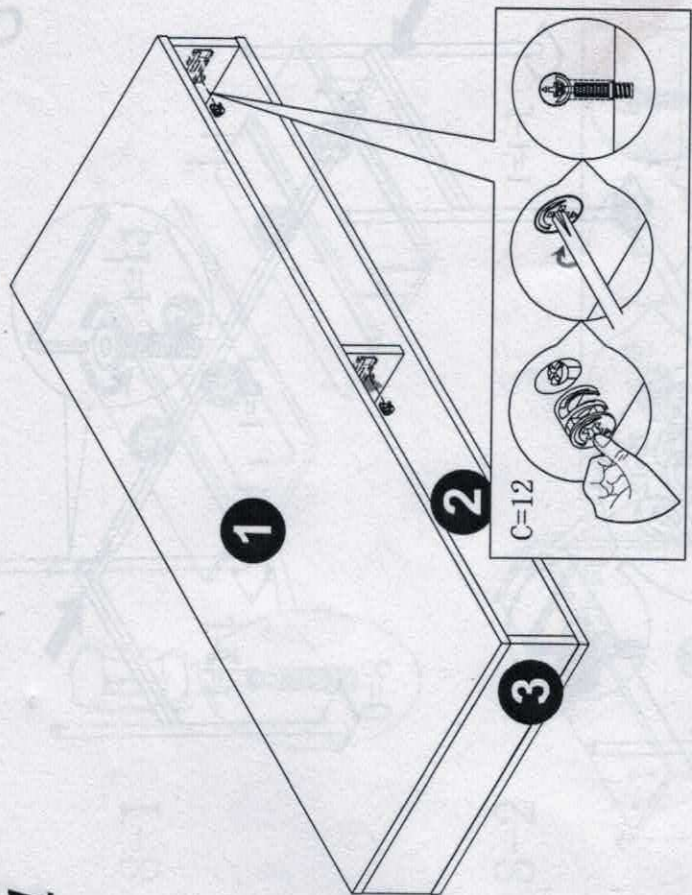

3

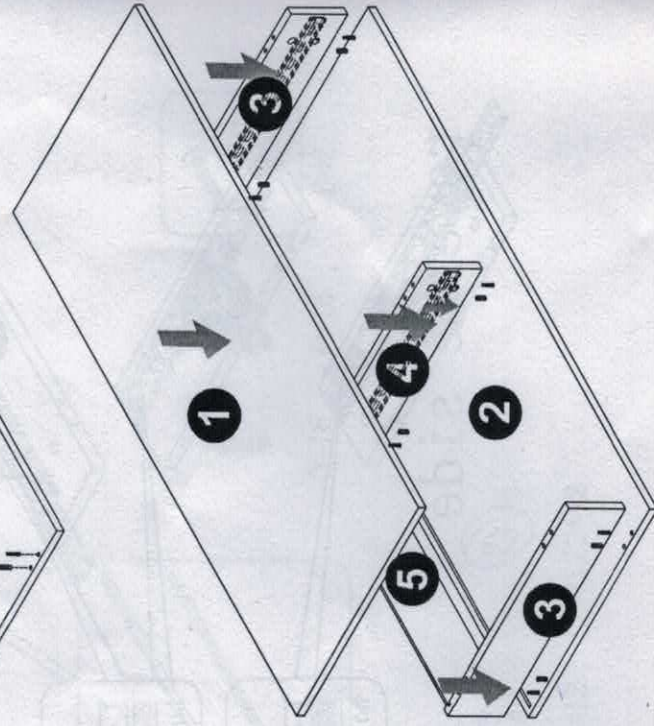

5

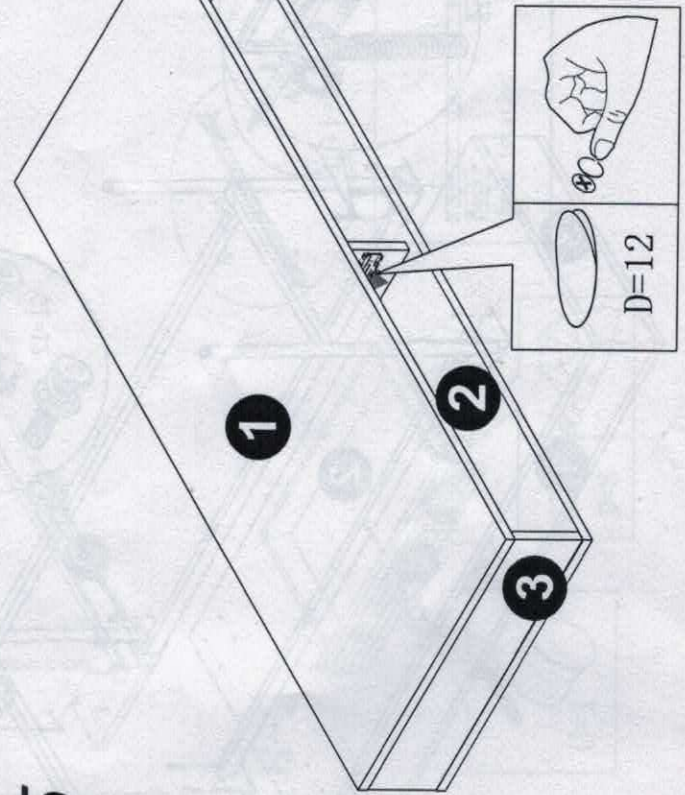

6

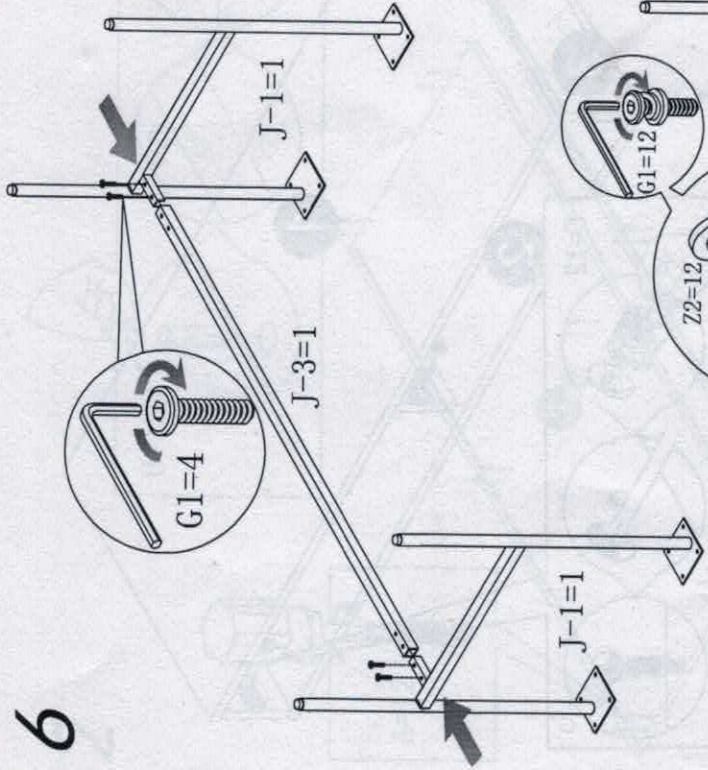

7

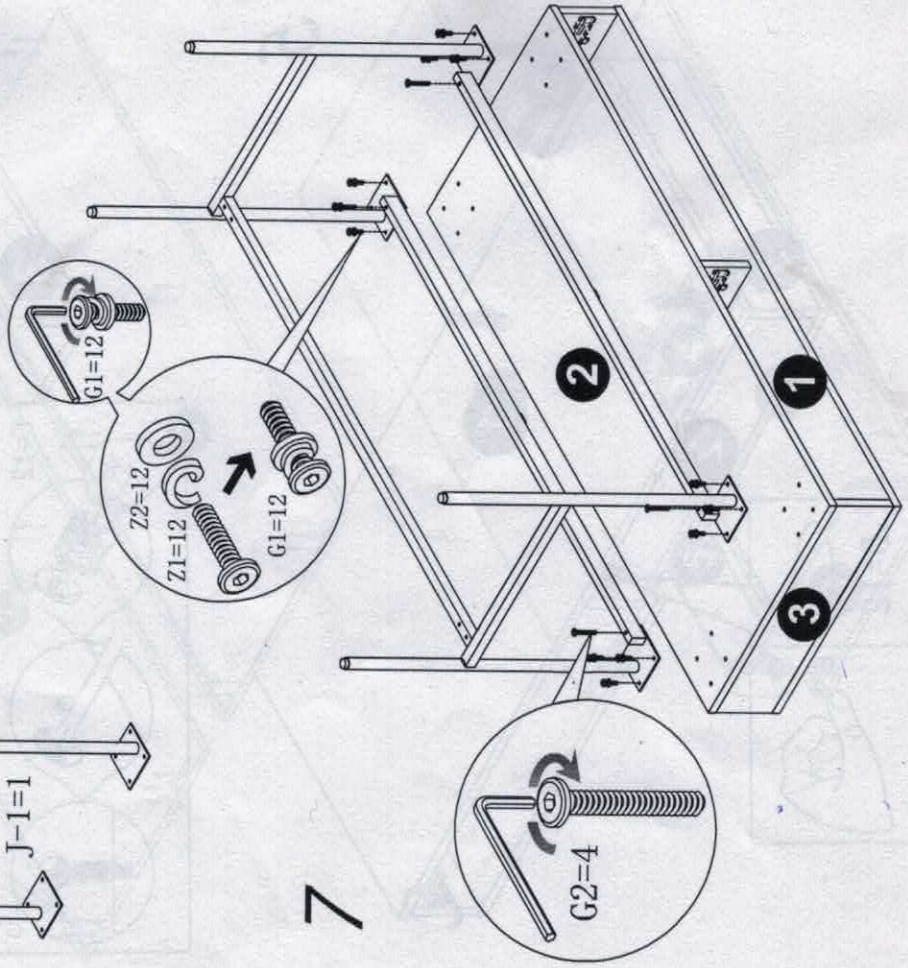

8

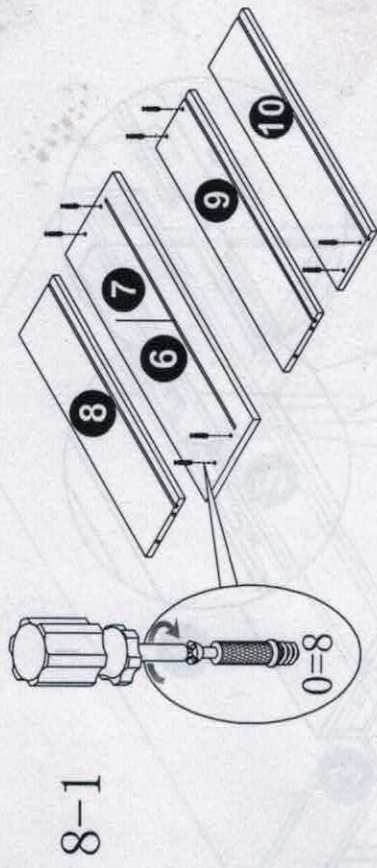

8-2

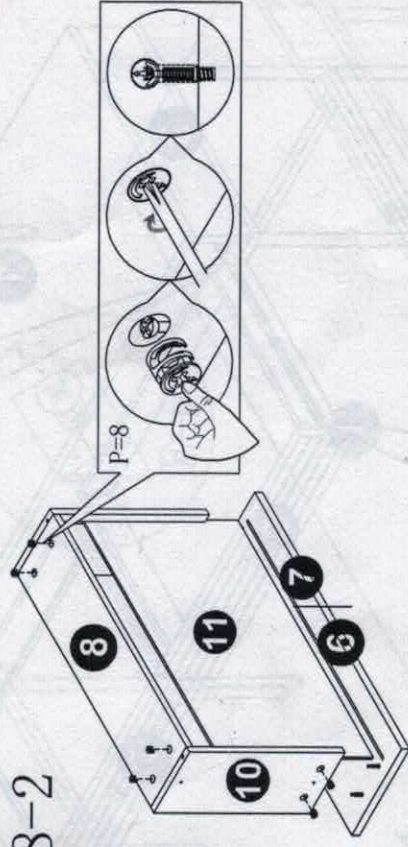

8-3

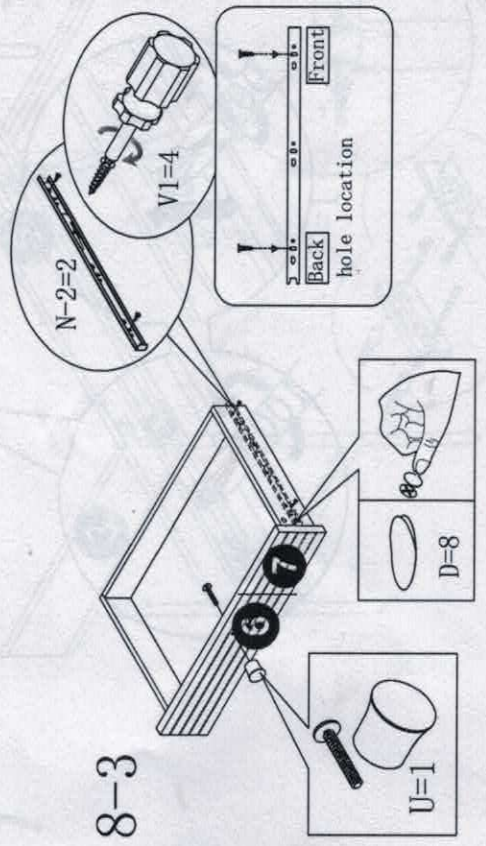

X2

9

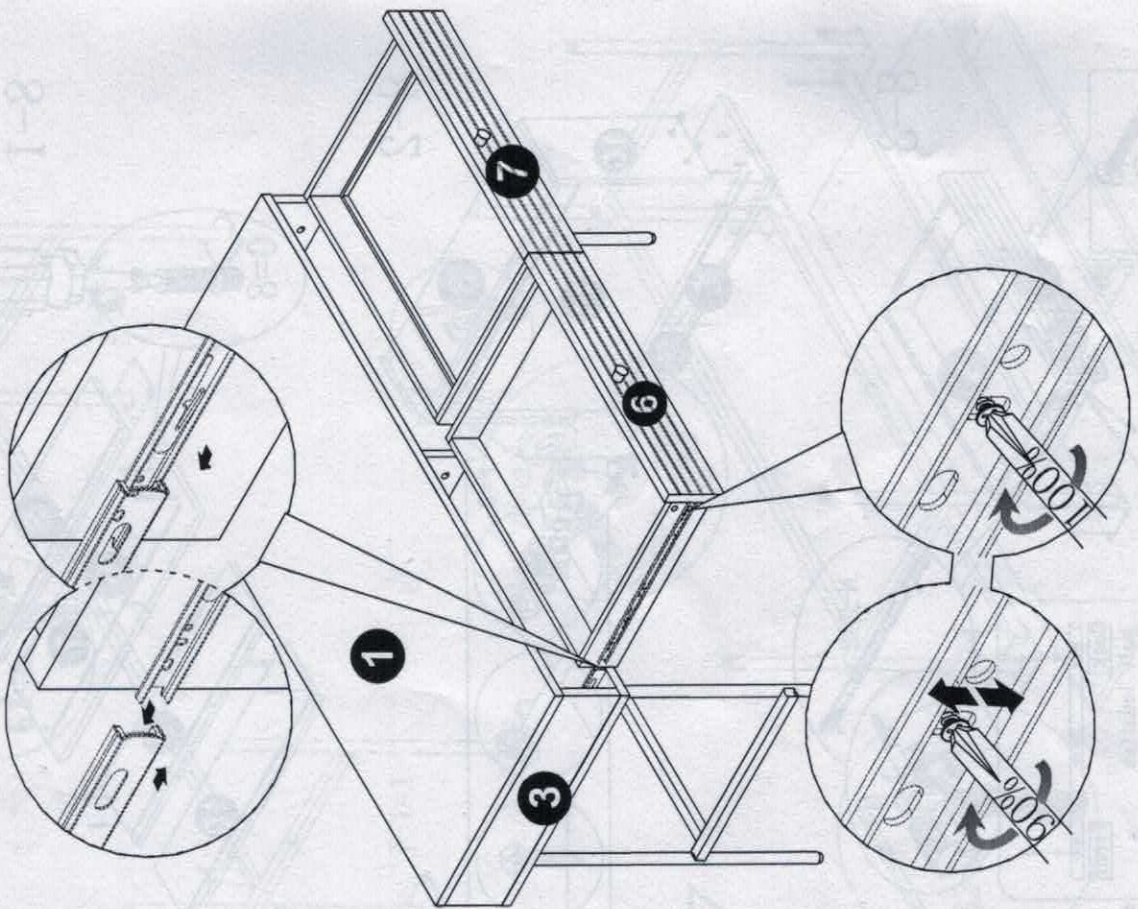

10

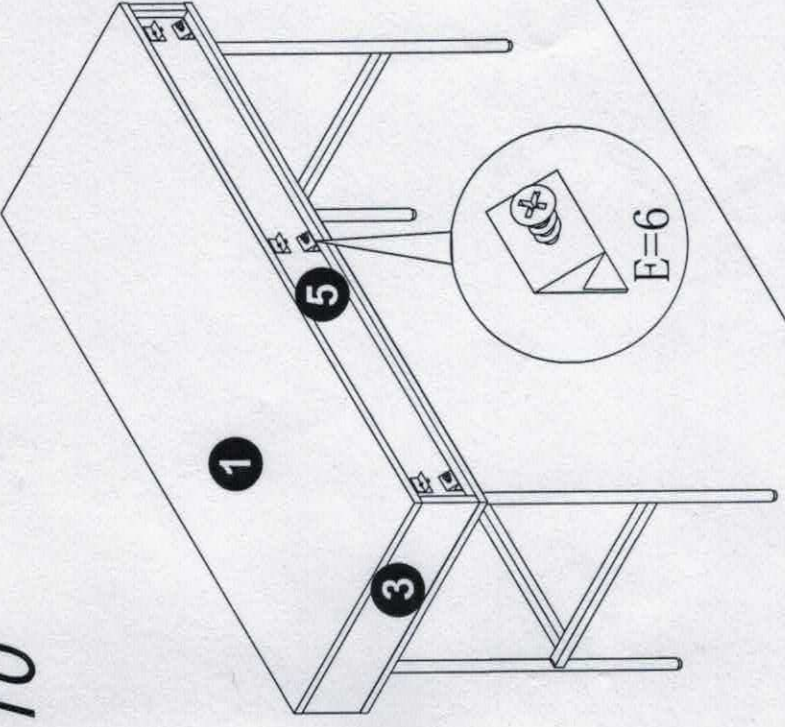

11

